

LSI Cabinet Design and Construction Details

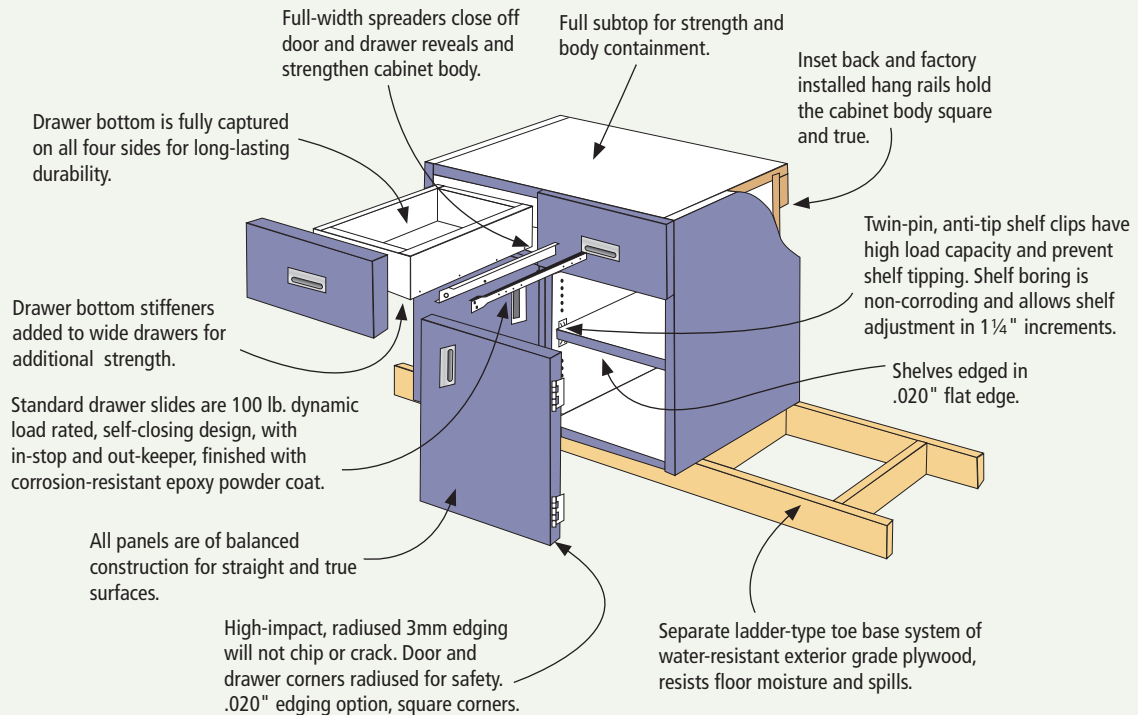

L-44

- Overlay design
- Laminate door, drawer
- .020" or 3mm edging
- 5-knuckle or concealed hinge



L-47

- Overlay design
- Postformed door & drawer
- 3mm edging
- Concealed hinge



L-55

- Flush design
- Laminate door, drawer
- 3mm edging
- 5-knuckle hinge



Fusion

- Overlay design
- Melamine door, drawer
- .020" or 3mm edging
- 5-knuckle or concealed hinge



ProLab

- Flush design
- Wood veneer door, drawer
- Wood 3mm edging
- 5-knuckle hinge



ProLab 2

- Overlay design
- Wood veneer door, drawer
- Wood 3mm edging
- 5-knuckle or concealed hinge



Executive

- Overlay design
- Rigid Thermofoil door, drawer
- Integral edging
- Concealed hinge



Music

- Flush design
- Wire grille or laminate door
- 3mm edging
- 5-knuckle hinge

LSI Cabinet Design and Construction Details

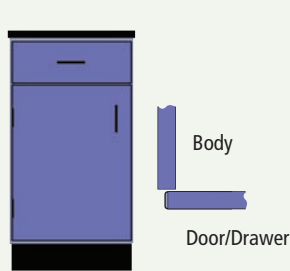

Overlay door design
@ L-44, L-47, ProLab 2,
Executive, Fusion.

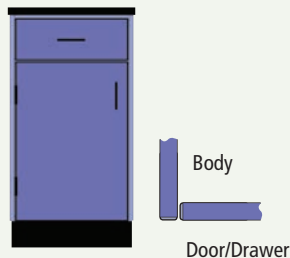

Flush door design
@ L-55, ProLab, Music.

.020" Edge Profile



Body panels edged with .020 edging.

3mm Edge Profile



Doors / Drawers edged with 3mm edging.

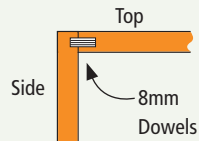

Cabinet body joint detail

3mm Edge Profile



Body panels and Doors /
Drawers edged with 3mm
edging.

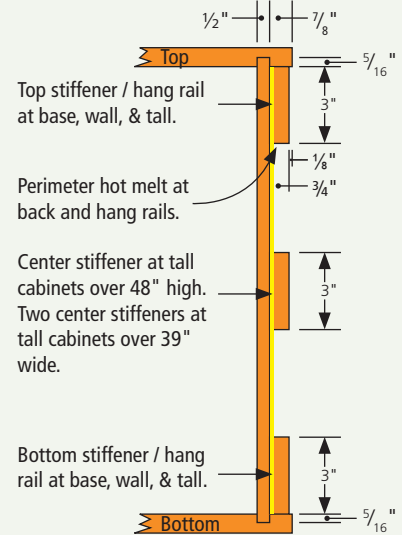

Cabinet Back Detail

Cabinet back is fully captured by the cabinet body and held by both mechanical fasteners and hot melt glue.

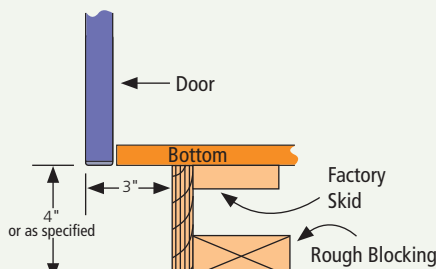

Base detail at cabinet front, side view.

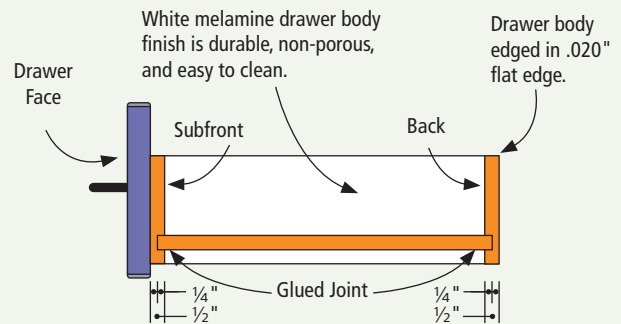

Drawer body detail, side section view.

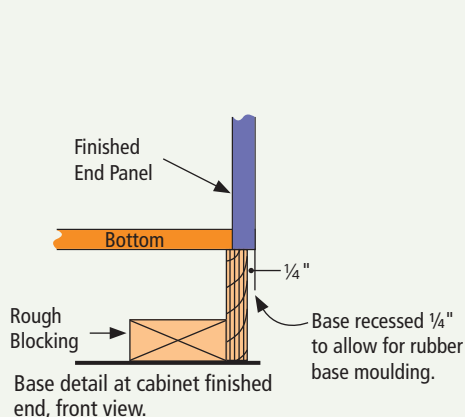

Base detail at cabinet finished end, front view.

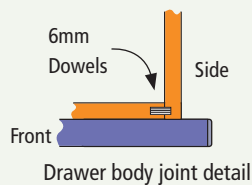

Drawer body joint detail

Drawer bottom stiffeners are added at wide drawer bodies.

1 @ 24" W, 2 @ 36" W, 3 @ 48" W.

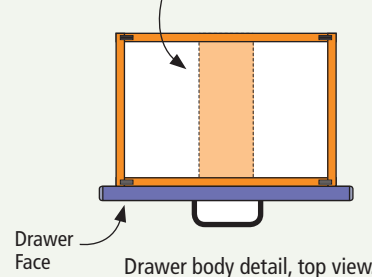

Drawer body detail, top view.

Library Shelving

A	B'	C	D
Published Nominal Height	Actual Total Height	Actual Body Height	Height Adds: 13/16" Top
42"	41 7/8"	41 1/16"	13/16"
60"	59 1/2"	58 11/16"	13/16"
72"	72 3/32"	71 9/32"	13/16"
84"	83 7/8"	83 7/8"	0"

Tall Cabinets

A	B'	C	D
Published Nominal Height	Actual Total Height	Actual Body Height	Height Adds: 4" Toe Base
72"	71 17/32"	67 17/32"	4"
84"	84 1/8"	80 1/8"	4"

Base Cabinets

A	B'	C	D
Published Nominal Height	Actual Total Height	Actual Body Height	Height Adds: 1 1/4" Top 4" Toe Base
26"	26 5/32"	20 29/32"	5 1/4"
30"	29 15/16"	24 11/16"	5 1/4"
34"	33 23/32"	28 15/32"	5 1/4"
36"	36 7/32"	30 31/32"	5 1/4"
39"	38 3/4"	33 1/2"	5 1/4"

Wall Cabinets

A	B
Published Nominal Height	Actual Total Height
15"	14 19/32"
18"	18 3/8"
24"	23 7/16"
30"	29 23/32"
36"	36 1/32"
42"	42 5/16"
48"	47 3/8"

Systems 90° Upper Cabinets

A	B
Published Nominal Height	Actual Total Height
24"	23 7/16"
30"	29 3/4"
36"	36 1/16"

Systems 90° Lower Cabinets

A ²	B	C	D
Actual Counter Height	Actual Body Height	Height Adds: 1 1/4" Top	Clearance
30"	22 3/16"	1 1/4"	6 9/16"
33"	22 3/16"	1 1/4"	9 9/16"
36"	22 3/16"	1 1/4"	12 9/16"

Systems 90° Tall Cabinets











A	B	D
Actual Mounting Height	Actual Body Height	Clearance
84"	77 5/8"	6 3/8"

Notes:

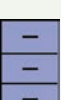
1. The actual total height may be greater than shown due to shimming for uneven floors.
2. Counter height shown is for cabinet-supported counters. If counters are independently supported, add 3/8" to the counter height.
3. Cabinet widths and depths as published in the catalog are actual.
4. Specific dimensions shown on shop drawings supersede the dimensions shown here.
5. Systems 90° Wall Rail may be mounted at any height required by project needs.



LSI DRAWER BODY SIZING

Cabinet Body Configuration	Drawer Height		Nominal Countertop Height			
			26"	30"	34"	36"
 6" Standard * Door	Face	Drawer	6.2"	6.2"	6.2"	6.2"
		Door	13.7"	17.5"	21.3"	23.8"
	Inside Depth	Drawer	2.8"	2.8"	2.8"	2.8"
 8" Standard ** Door	Face	Drawer	7.4"	7.4"	7.4"	7.4"
		Door	12.5"	16.3"	20.0"	22.5"
	Inside Depth	Drawer	4.7"	4.7"	4.7"	4.7"
 Writing board + 6" Standard Door	Face	Drawer	4.6"	4.6"	4.6"	4.6"
		Door	13.7"	17.5"	21.3"	23.8"
	Inside Depth	Drawer	1.5"	1.5"	1.5"	1.5"
 6" Standard * + 2 Equal	Face	Top	6.2"	6.2"	6.2"	6.2"
		2 Equal	6.8"	8.7"	10.6"	11.8"
	Inside Depth	Top	2.8"	2.8"	2.8"	2.8"
		2 Equal	2.8"	4.7"	7.8"	7.8"
 8" Standard ** + 2 Equal	Face	Top	7.4"	7.4"	7.4"	7.4"
		2 Equal	6.2"	8.1"	9.9"	11.2"
	Inside Depth	Top	4.7"	4.7"	4.7"	4.7"
		2 Equal	2.8"	4.7"	4.7"	7.8"
 3 Equal	Face	3 Equal	6.6"	7.9"	9.1"	9.9"
	Inside Depth	3 Equal	2.8"	4.7"	4.7"	4.7"
 6" Standard * + 3 Equal	Face	Top	6.2"	6.2"	6.2"	6.2"
		3 Equal	4.5"	5.8"	7.0"	7.8"
	Inside Depth	Top	2.8"	2.8"	2.8"	2.8"
		3 Equal	1.5"	2.8"	2.8"	4.7"
 4 Equal	Face	4 Equal	4.9"	5.9"	6.8"	7.4"
	Inside Depth	4 Equal	1.5"	2.8"	2.8"	4.7"
 6" Standard * + 4 Equal	Face	Top		6.2"	6.2"	6.2"
		4 Equal		4.3"	5.2"	5.9"
	Inside Depth	Top		2.8"	2.8"	2.8"
		4 Equal		1.5"	1.5"	2.8"
 5 Equal	Face	5 Equal	3.9"	4.7"	5.4"	5.9"
	Inside Depth	5 Equal	1.3"	1.5"	2.8"	2.8"









All dimensions rounded to the nearest tenth of an inch.

* 6" Standard top drawer is 6.2" high, drawer face to line up horizontally with other products, such as sink cabinet aprons or knee space blank panels.

** 8" Standard top drawer is 7.4" high.

LSI DRAWER BODY SIZING

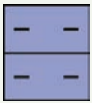
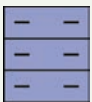







Cabinet Body Configuration	Drawer Height		Nominal Countertop Height			
			26"	30"	34"	36"
 6 Equal	Face			3.9"	4.5"	4.9"
	Inside Depth			1.3"	1.5 "	1.5 "
 7 Equal	Face				3.8"	4.2"
	Inside Depth				1.3 "	1.5"
 2 Equal + File	Face	2 Equal	4.0"	5.8"	7.8"	9.0"
		File	11.8"	11.8"	11.8"	11.8"
	Inside Depth	2 Equal	1.3 "	2.8"	4.7"	4.7"
		File	9.0"	9.0"	9.0"	9.0"
 3 Equal + File	Face	3 Equal		3.9"	5.1 "	6.0"
		File		11.8"	11.8"	11.8"
	Inside Depth	3 Equal		1.3"	1.5 "	2.8"
		File		9.0"	9.0"	9.0"
 2 File	Face	Top		11.8"	13.7"	15.0"
	Inside Depth	2 Equal		9.0"	9.0"	9.0"
 6" Standard * + 2 File	Face	Top				6.2"
		2 File				11.8"
	Inside Depth	Top				2.8"
		2 File				9.0"
 2 Lateral File	Face			11.8"	13.7"	15.0"
	Inside Depth			9.0"	9.0"	9.0"
 3 Equal Paper	Face		6.6"	7.9"	9.1 "	9.9"
	Inside Depth		2.8"	4.7"	4.7"	4.7"
 4 Equal Paper	Face		4.9"	5.9"	6.8"	7.4"
	Inside Depth		1.5 "	2.8"	2.8"	4.7"
 5 Equal Paper	Face		3.9"	4.7"	5.4"	5.9"
	Inside Depth		1.3"	1.5"	2.8"	2.8"

All dimensions rounded to the nearest tenth of an inch.

* 6" Standard top drawer is 6.2" high, drawer face to line up horizontally with other products, such as sink cabinet aprons or knee space blank panels.

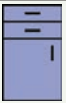
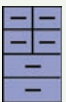

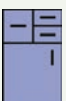
LSI DRAWER BODY SIZING

Cabinet Body Configuration	Drawer Height		Nominal Countertop Height			
			26"	30"	34"	36"
 6 Equal Paper	Face			3.9"	4.5"	4.9"
	Inside Depth			1.3"	1.5"	1.5"
 7 Equal Paper	Face				3.8"	4.2"
	Inside Depth				1.3"	1.5"
 3" Stacked Door	Face	2 Equal	3.7"	3.7"	3.7"	3.7"
		Door	12.5"	16.3"	20.0"	22.5"
	Inside Depth	2 Equal	1.3"	2.8"	4.7"	4.7"
 6" Split Standard + Equal height	Face	Top 2 Drawers		6.2"	6.2"	6.2"
		Lower Drawers		5.7"	7.0"	7.8"
	Inside Depth	Top 2 Drawers		2.8"	2.8"	2.8"
		Lower Drawers		2.8"	2.8"	4.7"
 2 Equal (non-file)	Face		10.0"	11.8"	13.7"	15.0"
	Inside Depth		4.7"	7.8"	7.8"	7.8"
 Non-file File	Face	Top	8.1"	11.8"	15.6"	18.1"
		File	11.8"	11.8"	11.8"	11.8"
	Inside Depth	Top	4.7"	7.8"	7.8"	7.8"
		File	9.0"	9.0"	9.0"	9.0"
 8" Standard + Stacked Door	Face	Large	7.4"	7.4"	7.4"	7.4"
		Stacked	3.7"	3.7"	3.7"	3.7"
	Inside Depth	Large	4.7"	4.7"	4.7"	4.7"
		Stacked	1.3"	1.3"	1.3"	1.3"
 4" Knee Space	Face		4.1"	4.1"	4.1"	4.1"
	Inside Depth		1.5"	1.5"	1.5"	1.5"
 6" Knee Space	Face		6.2"	6.2"	6.2"	6.2"
	Inside Depth		2.8"	2.8"	2.8"	2.8"

Drawer Dimensions:

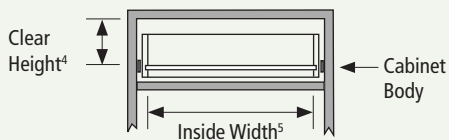

Drawer body front view

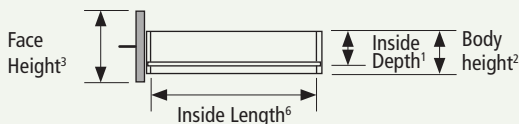

Drawer body side view

1. Inside Depth is the distance from the top of the drawer bottom to the top of the drawer body sides. Inside Depth is given in the table above.
2. Body Height is the distance from the bottom to the top of the drawer body side or back. For standard drawers, it is 1" greater than the Inside Depth. For file drawers, it is 5/8" greater than the Inside Depth.
3. Face Height is the distance from the bottom to the top of the drawer front. Face Height is given in the table above.
4. Clear Height is the distance from the top of the drawer bottom to the bottom of the cabinet top or spreader above. Clear Height represents the tallest object that can be placed in a drawer and have the drawer close. Clear Height is approximately the Face Height minus 2" .
5. Inside Width is the distance from the inside left to the inside right of the drawer body. Inside Width is approximately the cabinet width minus 3 5/8"
6. Inside Length is the distance from the inside front to the inside back of the drawer body. Inside Length is 19" for 24 1/4" deep cabinets, 24 3/4" for 29 1/4" deep cabinets, and 30 3/4" for 35 1/4" deep cabinets.

All dimensions rounded to the nearest tenth of an inch.

* 6" Standard top drawer is 6.2" high, drawer face to line up horizontally with other products, such as sink cabinet aprons or knee space blank panels.

LSI IN-WALL BLOCKING REQUIREMENTS



Soffits	<p>1/4" minimum overhang</p>	<p>Gypsum Board Soffits: LSI recommends that soffits extend beyond the face of the cabinets by a minimum of 1/4".</p> <p>A standard wall cabinet with door is 14 1/4" deep, so:</p> <p style="margin-left: 40px;">14 1/4" deep cabinet + 1/4" min. overhang = 14 1/2" min. soffit depth</p> <p>A standard tall cabinet with door is 24 1/4" deep, so:</p> <p style="margin-left: 40px;">24 1/4" deep cabinet + 1/4" min. overhang = 24 1/2" min. soffit depth</p> <p>At an open end condition, LSI recommends an end overhang of 1". LSI requires soffit dimensions be field verified prior to cabinet production.</p>	<p>Plastic Laminate Soffits: LSI recommends that the soffit panel be mounted flush with the door fronts. At an open end condition, LSI recommends an end overhang of 3/8".</p>
----------------	------------------------------	---	---

Electrical Rough-In for Standard and Systems 90° Cabinets	Diagram	A Nominal Top Height	B ¹ Actual Backsplash Height
Standard Base Cabinets		26"	30 3/16"
		30"	34"
		34"	37 3/4"
		36"	40 1/4"
Systems 90 Lower Cabinets		39"	42 3/4"
		30"	34"
		33"	37"
		36"	40"

- Column E is the height to the top of the backsplash. It is the minimum height to the bottom of the fixture plate and does not include growth in height due to cabinet shimming. The backsplash height shown is based on a 4" high backsplash, 1/4" countertop, and 4" toe base.

In-wall Blocking for Systems 90° Cabinets	Diagram	A Nominal Top / Cabinet Height	B ¹ Blocking Centered At	C ¹ Additional Blocking Centered At
Base ²		30"	27" ³	
		33"	27" ³	
		36"	27" ³	
Wall		84"	81 1/2"	
		84"	81 1/2"	27" ³

Notes:

- Blocking should be centered at the height shown.
- Blocking location based on 1/4" countertop.
- Centerline location of wall rail.
- Recommended in-wall blocking material, unless specified otherwise, is 2 x 6 inch wood.
- Systems 90° casework can be located at any height. Adjust blocking heights accordingly.
- Specific information on the project shop drawings supersedes this chart.

In-wall Blocking for Standard Casework	Diagram	A Nominal Top / Cabinet Height	B ¹ Blocking Centered At
Base ²		26"	22 3/4"
		30"	26 1/2"
		34"	30 1/2"
		36"	32 3/4"
		39"	35 1/4"
Wall ³		72"	69" ³
		84"	81 1/2" ³
Tall ⁴		72"	69"
		84"	81 1/2"

Notes:

- Blocking should be centered at the height shown.
- Blocking location based on 1/4" countertop and 4" toe base.
- A second piece of blocking should be installed near the bottom of the wall cabinet. The location can be determined by: Mounting Height - Cabinet Height + 3" = Center of Blocking.
- Blocking location based on 4" toe base.
- Recommended in-wall blocking material, unless specified otherwise, is 2 x 6 inch wood.
- Specific information on the project shop drawings supersedes this chart.

